



Thermally Activated Gas Shut-Off Devices

GTI Project Manager:

Ray Deatherage
847-768-0942
rdeatherage@gti.energy

GTI Technical Contact:

Marta Guerrero Merino
847-311-1501
mguerreromerino@gti.energy

GTI Project Team:

Vitaliy Gnatenko

1700 S. Mount Prospect Rd.
Des Plaines, Illinois 60018
www.gti.energy

Provided by:



Teco Americas, LLC
263 Cox Street
Roselle, NJ 07203

<https://tecoamericas.com>
inquiry@tecoamericas.com
908-488-0909

Signature Page

Print or typed

First M. Last

Signature

Date

AUTHOR:

Marta Guerrero Merino

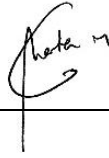

07/02/2019

Title: Associate Engineer

REVIEWED BY:

Ray Deatherage



07/02/2019

Title: Senior Program Manager

APPROVED BY:

Dennis Jarnecke



07/02/2019

Title: Director, R&D

Legal Notice

This information was prepared by Gas Technology Institute (“GTI”) for Operations Technology Development (OTD).

Neither GTI, the members of GTI, the Sponsor(s), nor any person acting on behalf of any of them:

a. Makes any warranty or representation, express or implied with respect to the accuracy, completeness, or usefulness of the information contained in this report, or that the use of any information, apparatus, method, or process disclosed in this report may not infringe privately-owned rights. Inasmuch as this project is experimental in nature, the technical information, results, or conclusions cannot be predicted. Conclusions and analysis of results by GTI represent GTI's opinion based on inferences from measurements and empirical relationships, which inferences and assumptions are not infallible, and with respect to which competent specialists may differ.

b. Assumes any liability with respect to the use of, or for any and all damages resulting from the use of, any information, apparatus, method, or process disclosed in this report; any other use of, or reliance on, this report by any third party is at the third party's sole risk.

c. The results within this report relate only to the items tested.

Table of Contents

	Page
Signature Page.....	i
Legal Notice	ii
Table of Contents	iii
Table of Figures	iv
List of Tables	iv
Executive Summary	6
Introduction.....	7
Market Availability	8
Teco FireBag®	8
Performance Testing Results.....	8
Test Equipment	9
Testing Procedures	10
Teco FireBag®	11
<i>Specifications</i>	11
<i>Visual Examination</i>	12
<i>Sectioning and Material Characterization</i>	13
<i>Pressure Drop Test</i>	15
<i>Trip Test</i>	16
<i>Seat Test</i>	17
<i>Integrity Test</i>	17
Discussion and Results	21
Teco FireBag®	21
Conclusion	21
References	23
List of Acronyms	23

Table of Figures

	Page
Figure 1. Example of Shutoff Device and Cross Section.....	7
Figure 2. FireBag® Shutoff Device Examples.	8
Figure 3. Test Rig Design for Device Performance Testing.	9
Figure 4. Assembled Test Rig for Device Performance Testing.	10
Figure 5. Performance Test Flow Chart.	11
Figure 6. Teco FireBag® Installation Locations.	11
Figure 7. Teco FireBag® Multi-Meter Gas Manifold Metering Applications	12
Figure 8. Teco FireBag® - Plug and Spring Mechanism.	13
Figure 9. Teco FireBag® Device - Spring and Plug Removed.....	13
Figure 10. Teco FireBag® Device - Plug Sliced in Half.....	14
Figure 11. Teco FireBag® Device - Separated Plug from Pressed in Piece.....	14
Figure 12. Teco FireBag® Device - Contact Surface.....	15
Figure 13. Teco FireBag® Test Assembly Set-up.....	15
Figure 14. Teco FireBag® Pressure Drop vs Flow.	16
Figure 15. Teco FireBag® Trip Test Results for Sample #1.....	17
Figure 16. Teco FireBag® Integrity Test for Sample #2.	18
Figure 17. Teco FireBag® Device After Integrity Test.....	19
Figure 18. Teco FireBag® Device After Integrity Test - Inlet View and Spring.	19
Figure 19. Teco FireBag® Device After Integrity Test - Outlet View.....	20

List of Tables

	Page
Table 1. Teco FireBag® Device Specifications.....	8
Table 2. Test Rig Equipment Information.	10
Table 3. Teco FireBag® Device Specifications.....	12

Table 4. Teco FireBag® Shutoff Activation Temperatures.17

Executive Summary

The objective of this project was to identify commercially available thermally activated gas shut-off devices for the natural gas industry, evaluate the requirements for installation, and conduct performance testing. Installation of this type of shut-off device may help prevent or reduce the escape of natural gas in the event of a fire, preventing explosions and the spreading of fire at a customer's premise.

Currently, there are no U.S. standards governing the design, operation, or installation requirements for this type of shut-off device. However, there is a Massachusetts state standard, Section 75A, that does state that a gas measuring device cannot be installed unless there is a means for preventing or retarding the escape of gas in case of fire. As a result of this state standard, there are total of six Teco FireBag® thermal-activated devices listed as approved by the Massachusetts Office of Consumer Affairs and Business Regulation. There are several European, German, and Italian standards governing the use of thermal-activated safety devices.

The main conclusion from the performance testing conducted on these different devices is that the flow rate passing through the thermal shutoff device at the time it is exposed to excessive heat, will cause the activation temperature to increase above published temperatures by the manufacturer. It is known that the activation temperature increases with the flow rate. The DIN 3586 standard testing requirements for trigger temperatures specify no flow running through the device in order to standardize results across all devices. During the tests performed in this project, it was found that at a flow rate of 10 scfh, the activation temperature increased by over 20% above the published activation temperatures obtained from performing the tests under no flow conditions. Also, the technology and seal-off method used by the thermal shutoff manufacturers is different, therefore, all of their published activation temperatures differ among them. According to published activation temperatures by the manufacturers, one device activates between 203°F - 212°F, the second device activates at 302°F +/- 50°F, and the third at 350°F - 425°F. The materials controlling the activation mechanism were characterized as well as the activation mechanism itself was characterized to better understand the device limitations and capabilities. The pressure drops obtained for all three manufacturers were adequate for the application of each device type.

Overall, the performance test results of this project support that thermally-activated shutoff devices can be relied on, if installed per manufacturer's instructions, to secure the flow of natural gas when exposed to elevated temperatures from a structure fire. Thermal shutoff devices do serve a need within the natural gas distribution industry and industry stakeholders should identify the applications that make the most sense for installing these safety shutoff devices within their community and gas distribution systems.

Listed are potential future projects related to thermally-activated shutoff devices to consider.

- Development efforts for creating a U.S. and Canadian standard(s) for governing the installation and operation of thermally-activated shutoff devices.
- Conduct performance testing of high-pressure rated thermally-activated shutoff devices at low delivery pressures to confirm satisfactory pressure drops.

- Conduct performance testing at elevated flow rates to identify how high activation temperatures become at the different flows.
- Conduct research and development efforts to incorporate an EFV device into high-pressure rated thermally-activated shutoff devices.

Introduction

Thermally activated gas shutoff devices are not new to the natural gas industry. In fact, Massachusetts state regulations requires this type of shutoff device to be installed for all gas meters installed within a customer’s premise. Also, many European countries require the installation of an automatic thermal shutoff device at each appliance. One manufacturer, Teco Americas, claims to have over 12 million of their devices installed throughout the world. Currently, there are no federal or industry standards (e.g. 49 CFR Part 192, ANSI, ASME, etc.) governing the design, installation or operation parameters of these types of devices in the U.S or Canada. Only one known state agency, the Massachusetts Office of Consumer Affairs and Business Regulation, has been involved with the approval and regulation development for this type of safety device.

Installation of thermally activated gas shutoff devices at single meter, multi-meter, and appliance locations can significantly improve fire safety for natural gas customers. This improved safety is achieved without the need for expensive actuators, electrical power, heat detectors, or fire detectors. This type of shutoff device is a passive device and only activates when the ambient temperature reaches 212°F. Also, it is maintenance free, no regular inspections are required. Some device designs include an excess flow valve that will also activate in the event of excessive gas flow rates due to a ruptured or disconnected customer fuel line. See **Figure 1** for example of shutoff device and cross section of device operation.

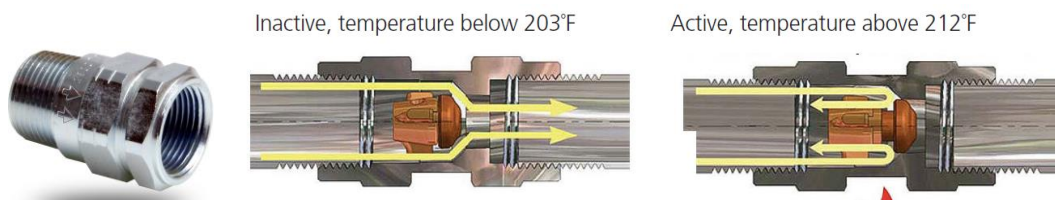

Figure 1. Example of Shutoff Device and Cross Section.

(Visuals courtesy of TECO Americas)

As reported by the U.S. Fire Prevention Agency, there were more than 371,500 residential fires reported in 2017. “Residential” was the leading property type for fire deaths at 2,695 individuals, fire injuries at 10,825 and fire dollar loss of \$7.8 billion in 2017.

Fires at residential premises with natural gas service lines pose a great risk to occupants, first responders and the general public due to the potential of uncontrollable release of gas that may fuel a residential fire or become a hazardous concentration within a premise that could lead to an explosion. If first responder response times of gas company and fire department personnel are delayed due to circumstances beyond their control (e.g., traffic congestion, severe weather, etc.),

the installation of automatic thermally-activated gas shutoff devices can help reduce the risk of a significant gas related incident from occurring due to a non-gas related house fire.

Market Availability

Teco FireBag®

Teco manufactures several different sizes and models of thermal-activated shutoff devices that can be installed upstream at gas appliances, upstream or downstream of gas meters, and in industrial type applications. Teco Americas is the U.S. distributor for the Teco FireBag® devices. **Figure 2** below provides examples of the different sizes and configurations of the FireBag® device.



Figure 2. FireBag® Shutoff Device Examples.

The technical data for the Teco FireBag® thermal shutoff device is shown below in **Table 1**.

Table 1. Teco FireBag® Device Specifications.

Device Sizes	Activation Temperature	Maximum Inlet Pressure (psig)	Heat Resistance
1/2", 3/4", 1"	Between 203°F and 212°F	100	1,697°F 60 minutes
1-1/4", 1-1/2", 2"			1,202° F 30 minutes

Performance Testing Results

Performance testing was performed for each of the manufacturers on the different style fittings that they manufacture. The goal of this testing was to confirm published performance specifications and identify any potential variables that affect the functionality of these thermally-activated shutoff safety devices. As the performance testing progressed, the test matrices

designed evolved in response to the results of the preliminary tests performed. The procedures presented in this section reflect the final test matrix that all manufacturers and devices were tested to.

Test Equipment

Due to the nature of some of the devices tested, the equipment readily available at GTI could not accommodate the testing conditions needed in this testing. For this reason, a new test rig was designed and built. As it appears in **Figure 3**, the rig consists of two different portions, a low-pressure section, highlighted in blue, and a high-pressure portion, marked in orange. This design adds flexibility to the possibilities of the assembly, so that different devices falling within a wide range of pressures can be tested. Thermocouples were placed at the inlet and outlet of the tested device and also inserted at the surface of the sample. The flow was controlled using a high-precision manual valve placed downstream of the sample to simulate an increase or decrease in the demand of natural gas. The flow meter used included a display from which the value in SCFH was read out. The pressure drop was measured using the corresponding differential pressure transmitter (low or high pressure). The piping where the device was assembled ran through the radiant oven. The assembled test rig is shown in **Figure 4**. The test equipment used to control and measure flows along with heating the test devices is listed in **Table 2**.

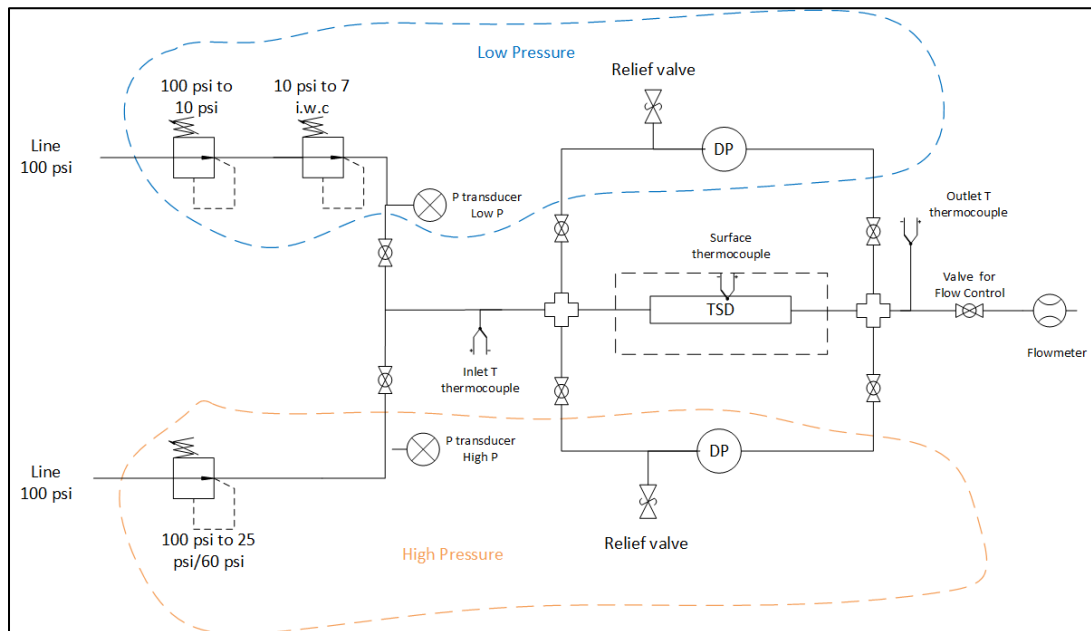

Figure 3. Test Rig Design for Device Performance Testing.

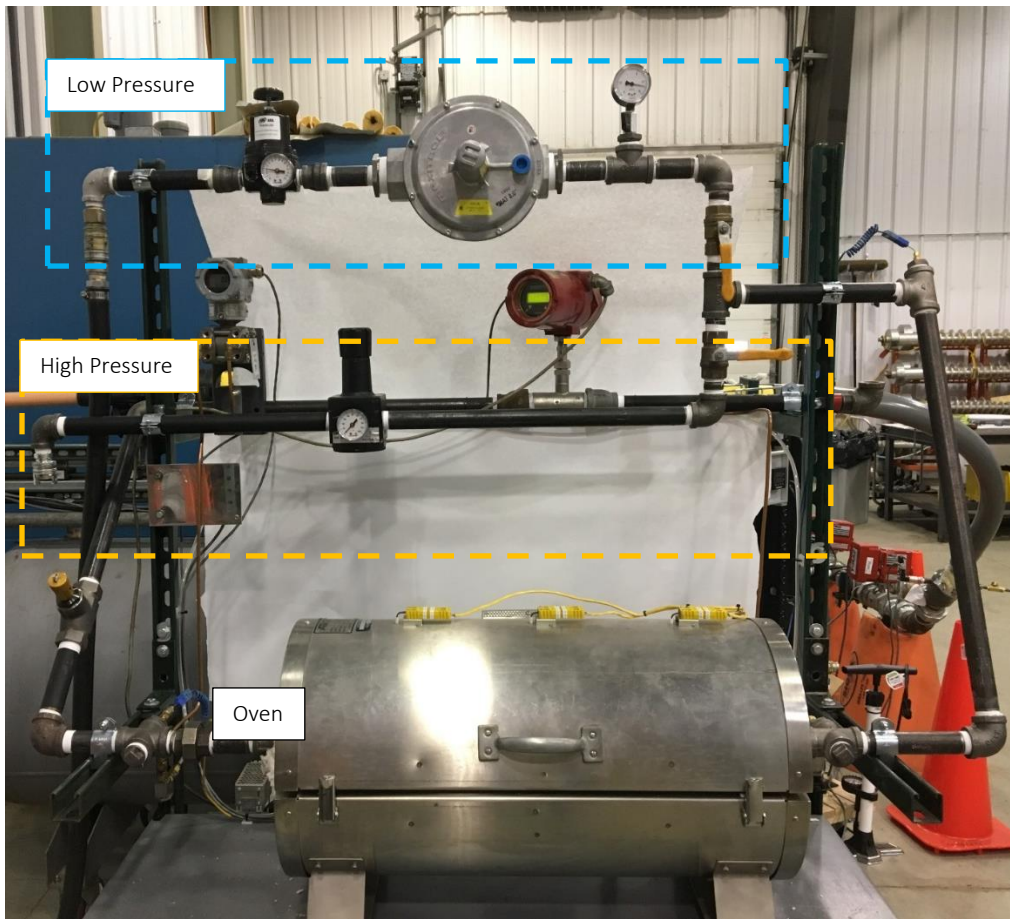

Figure 4. Assembled Test Rig for Device Performance Testing.

Table 2. Test Rig Equipment Information.

Description	Manufacturer/Model	Specifications
Flow Meter	Sierra Instruments 780S series	0-2500 scfh, $\pm 0.2\%$ FS
Low P Differential Pressure Transmitter	Dwyer 607-4	0 - 2 i.w.c, $\pm 0.50\%$ FS
High P Differential Pressure Transmitter	Dwyer 3100MP-1-FM-1-1	0 - 6 i.w.c, $\pm 0.075\%$ FS
Oven	ATS Series 3210	Max T 1200 °C
Oven Controller	ATS Temperature Control System	N/A
High P regulator	Wilkerson R39-08-F0G0	0 - 125 psig
First Low P regulator	ARO PR4055-200	0 - 60 psig
Second Low P regulator	Maxitrol 325-9L	7" - 11"

Testing Procedures

All the devices were subjected to the same tests. Some of the test conditions were adapted to match the characteristics of each device. The specific conditions applied to each particular device will be explained in the Test Procedures section. **Figure 5** presents the general flow chart that

shows the path followed for each tested sample. All the tests were performed using compressed air. The common procedures followed with all manufacturers models for each test were:

- Visual Examination: Samples were evaluated for overall appearance and to confirm there were no visible defects.
- Pressure Drop: Outlet flow was increased and kept constant until the pressure drop across the shutoff valve was stable.
- Trip Temperature: A specific temperature ramp rate was applied to all the test samples from the same model and the temperature at which the outlet flow stopped was recorded.
- Seat Test: After activation of the thermal shutoff mechanism and cooldown of the test sample, pressure was applied to the inlet side of the device to check the seal of the seat for leakage.
- Integrity Test: One test sample was exposed to the integrity test to confirm device performance at elevated temperatures for an extended period of time.

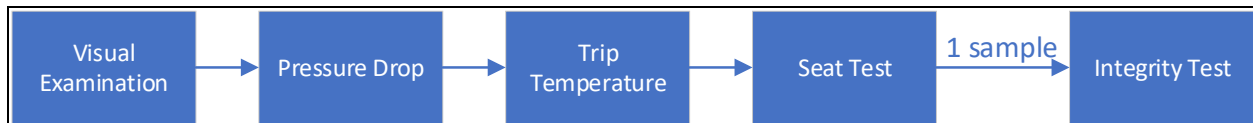

Figure 5. Performance Test Flow Chart.

Teco FireBag®

Specifications

The main function of Teco FireBag® devices is to stop the gas flow once a certain temperature is reached. This thermal shutoff safety device can be installed upstream or downstream of service pressure regulators and/or meter, as shown in **Figure 6**, as well as on customer piping to appliances. **Table 3** shows the specifications of the Teco FireBag® model tested in this project.

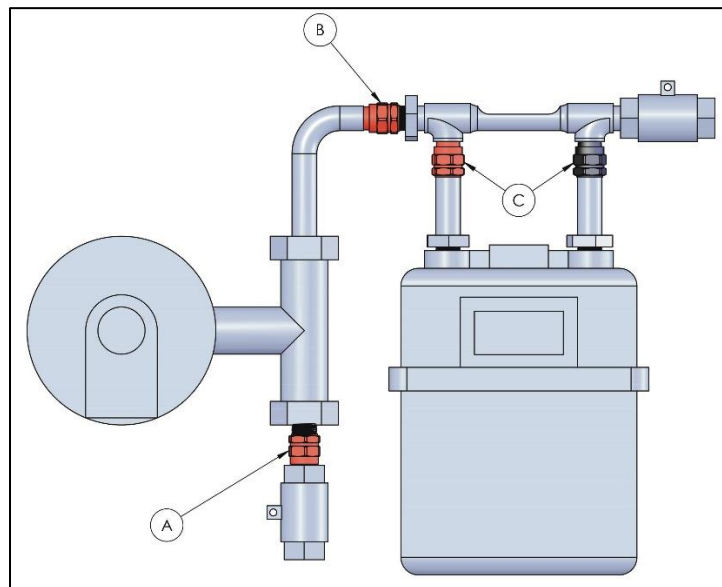

Figure 6. Teco FireBag® Installation Locations.

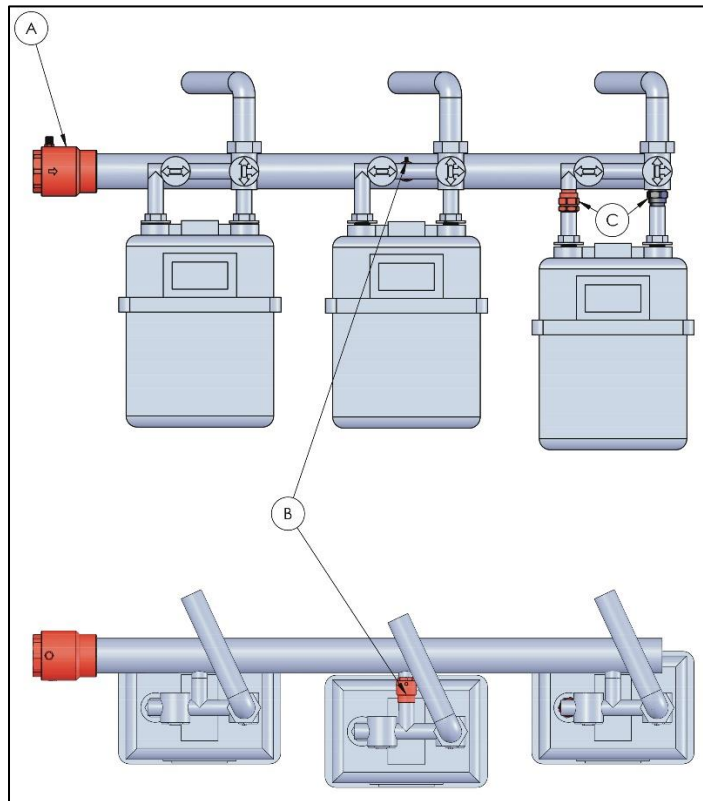

Figure 7. Teco FireBag® Multi-Meter Gas Manifold Metering Applications

Table 3. Teco FireBag® Device Specifications.

Inlet	Male ¼" NPT
Outlet	Female ¼" NPT
Activation Temperature without flow	203°F to 212°F
Max. Pressure	72.5 psig
Heat Resistance	1,697°F for 60 minutes

Visual Examination

The devices tested were visually inspected and they did not present any anomalies to the naked eye. The mechanism to stop the gas flow in Teco FireBag® fittings also includes a plug and a spring, although the arrangement is slightly different. The spring that pushes against the plug is nested inside it. The plug is held in place when the device is not activated by keeping the plug attached to

a pressed in piece as shown in **Figure 8**. The pressed marks of the spring and plug are shown in **Figure 9**.



Figure 8. Teco FireBag® - Plug and Spring Mechanism.

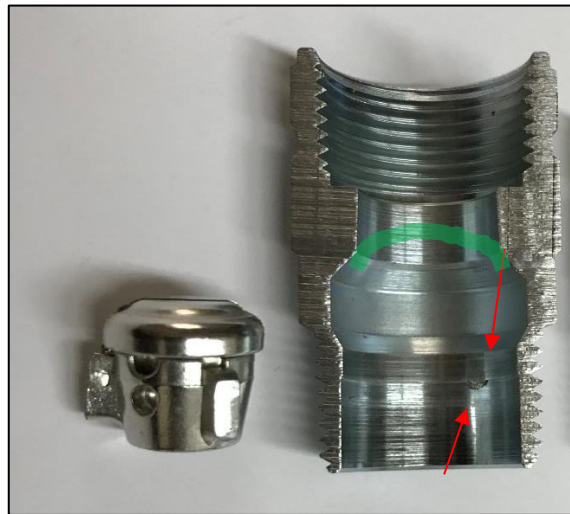

Figure 9. Teco FireBag® Device - Spring and Plug Removed.

Sectioning and Material Characterization

Due to the nature of the Teco FireBag® mechanism, the material characterization tests performed for Dormont SmartSense® and Pietro Fiorentini devices were not possible to be carried out with this device. A test was performed to identify what is the releasing mechanism between the pressed in piece and the plug. The plug was sliced in half and the half on the left in **Figure 10** and was

introduced in an oven at 212°F for one hour. The plug did not separate from the pressed in piece and then the temperature was raised up to 230°F. When the plug was taken out from the oven, separation was not evident. However, after forcing the plug out using a chisel, the pieces separated as show in **Figure 11**. The contact surface between the plug and the pressed in piece (**Figure 12**) appears to have some type of soft metal alloy that melts when the temperature is above 212°F.



Figure 10. Teco FireBag® Device - Plug Sliced in Half.



Figure 11. Teco FireBag® Device - Separated Plug from Pressed in Piece.



Figure 12. Teco FireBag® Device - Contact Surface.

Pressure Drop Test

The pressure drop test for the Teco FireBag® device was performed in the same manner as the tests performed for the Pietro Fiorentini devices (page **Error! Bookmark not defined.**). An example of the test assembly for the Teco Firebag® devices is shown in **Figure 13**. The pressure drop test results appear in **Figure 14**. All the values fall within a reasonable range from each other. The pressure drop at the highest flow rate of 400 scfh is around 0.5" w.c.

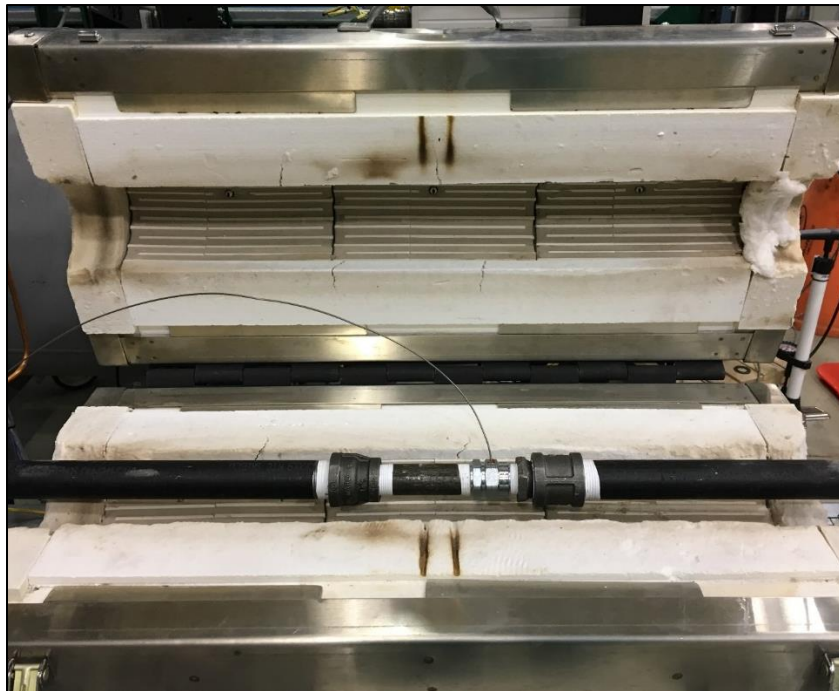

Figure 13. Teco FireBag® Test Assembly Set-up.

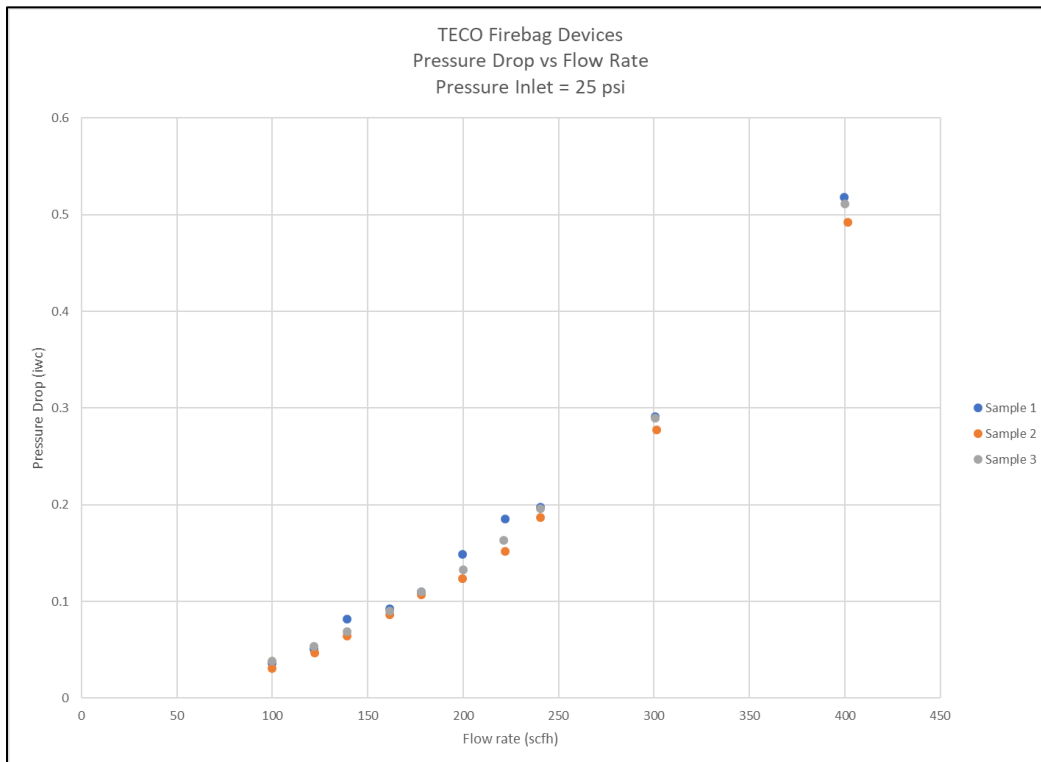

Figure 14. Teco FireBag® Pressure Drop vs Flow.

Trip Test

The trip temperatures for Teco FireBag® devices were calculated in the same manner as for Pietro Fiorentini devices. **Figure 15** shows that the activation mechanism in Teco FireBag® devices is very rapid. When performing the test, a clear click noise was heard once the device activated and the plug snapped into the seating edge. **Table 4** shows the trip temperature for each fitting as well as the average of 257°F for all devices. The standard deviation for all three samples is 4°F, which indicates that the product is very precise.

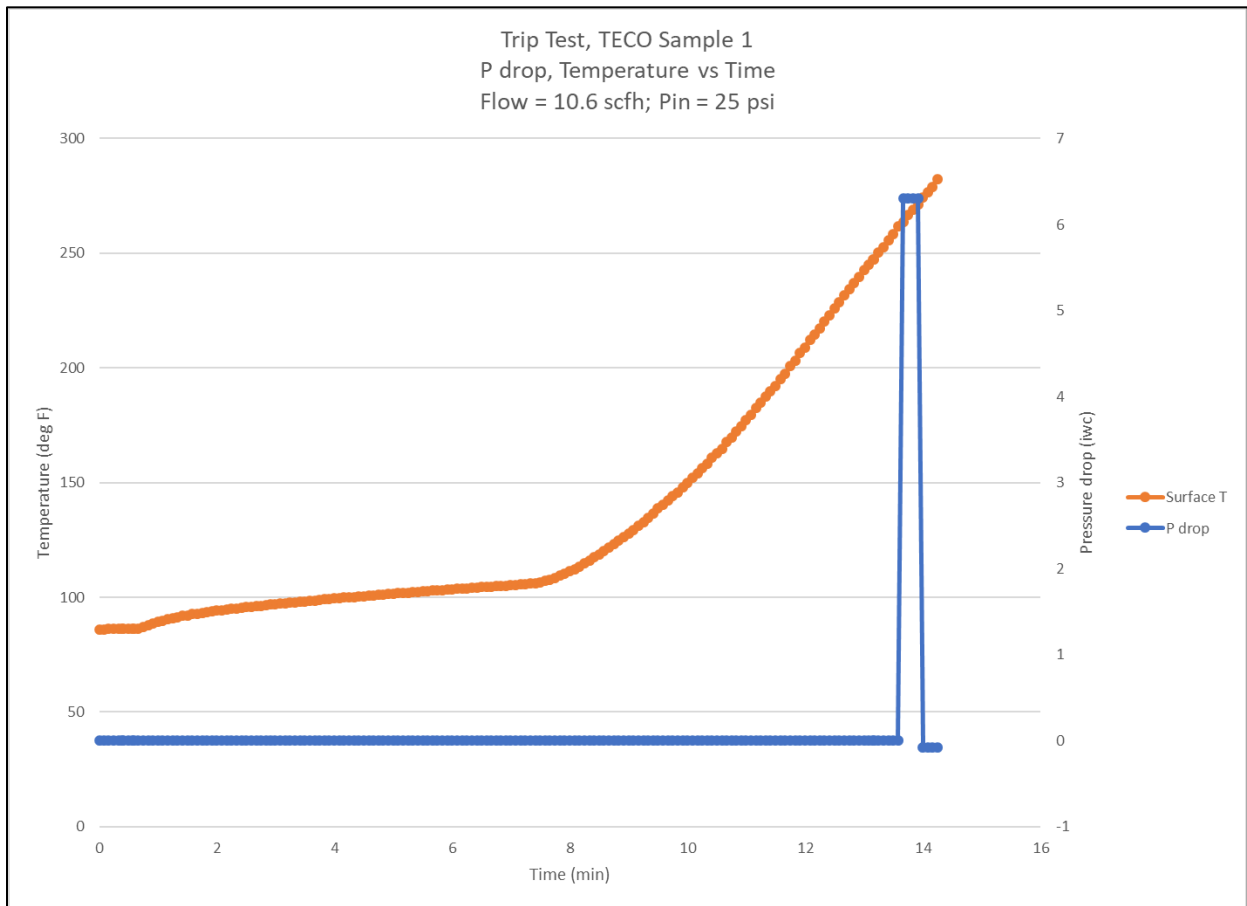

Figure 15. Teco FireBag® Trip Test Results for Sample #1.

Table 4. Teco FireBag® Shutoff Activation Temperatures.

	Temperatures (°F)
Sample #1	263
Sample #2	252
Sample #3	257
Average	257
Standard Deviation	4

Seat Test

Teco FireBag® devices were pressurized in the same way as the Pietro Fiorentini devices, at 60 psig and 100 psig for one minute at the inlet. All test samples passed the test, with no flow recorded downstream of the samples.

Integrity Test

In this test, the target was to hold temperature at 1,926°F for 60 minutes. Teco FireBag® Sample #2 was selected for this test. As it can be observed in **Figure 16**, the sample was at an average

temperature of 1,975°F for 66 minutes, from 49 minutes to 114 minutes, while the pressure drop signal from the transmitter was below 0, indicating that now flow was passing through the device. **Figure 17** presents the device assembled in the test rig after the test. As it is shown in **Figure 18**, when the device was disassembled from the rig, the spring fell apart from the interior of the sample. However, the plug was pushed in by hand and it did not move. **Figure 19** shows the outlet of the device after the integrity test.

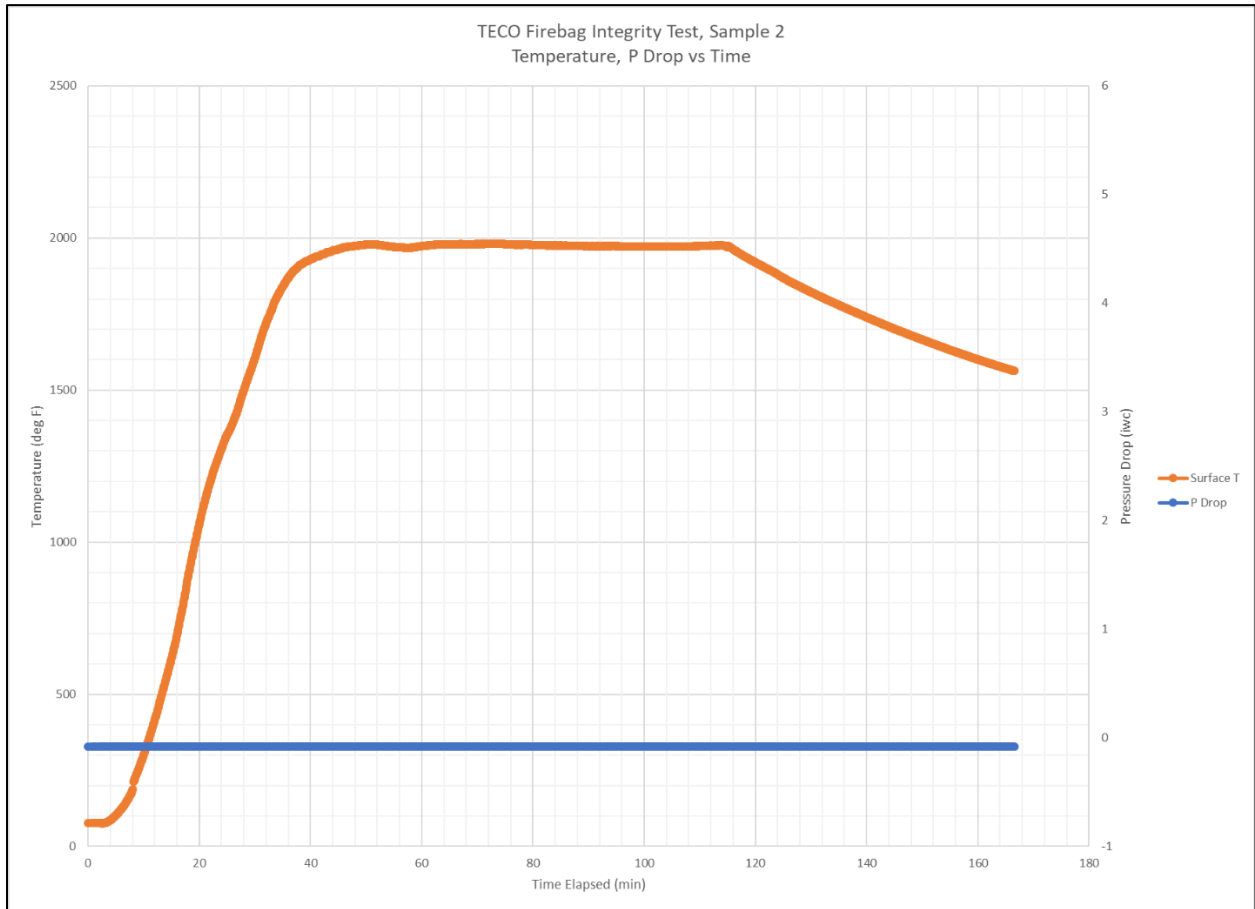

Figure 16. Teco FireBag® Integrity Test for Sample #2.



Figure 17. Teco FireBag® Device After Integrity Test.

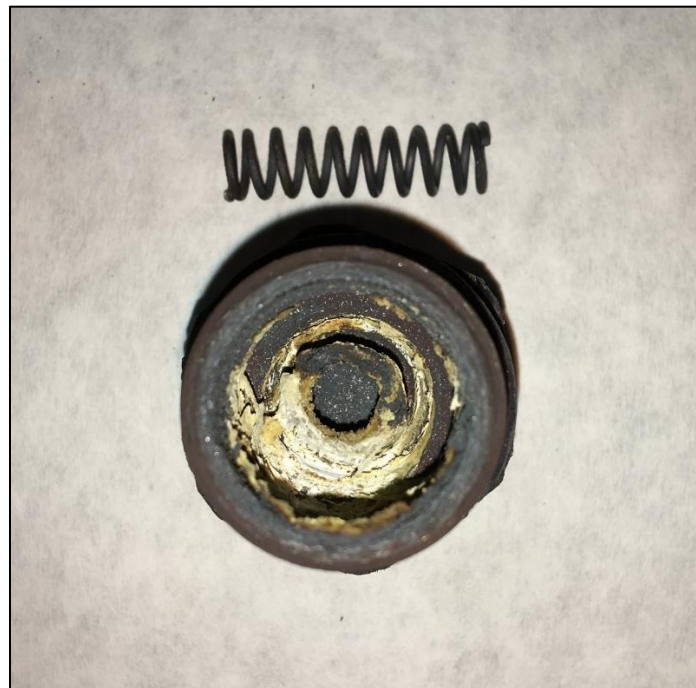

Figure 18. Teco FireBag® Device After Integrity Test - Inlet View and Spring.



Figure 19. Teco FireBag® Device After Integrity Test - Outlet View.

Discussion and Results

This section highlights the performance testing results for the thermal shutoff devices tested for each of the three manufacturers and any additional discussion points for consideration when installing these types of safety shutoff devices.

Teco FireBag®

Performance testing results of Teco FireBag® devices confirmed that this device is effective for controlling the flow of gas at high temperatures for prolonged periods of time. The average activation temperature of all Teco FireBag® test devices was 257°F, approximately 21% higher than their published activation temperature. Prior tests on the Teco FireBag® device performed at GTI (Project 20835.1.08) showed that in a no flow condition, the temperature range at which the devices tripped ranged from 205°F to 221°F, which is consistent with the manufacturer's specifications. The pressure drop for the Teco FireBag® device was a non-issue at the test pressures. The benefit of the Teco FireBag® type devices is that they come in many different sizes and configurations, therefore, allows industry stakeholders to increase safety by being able to adapt to different piping configurations upstream or downstream of gas company owned equipment. Based on performance testing at high temperatures for prolonged periods of time, the Teco FireBag® device should be considered as a primary safety device to install upstream and downstream of meter set assemblies to protect customer premises in the event of a structure fire event.

Conclusion

The performance test results of this project were consistent with what was expected from the devices studied. However, one test result that stood out for each of devices tested was that the thermal shutoff activation temperatures during project testing were more than 20% higher than shutoff activation temperatures published by the manufacturers. The main hypothesis for this difference is that the devices at GTI were tested with flow going through them, which would be closer to a real-case scenario. To standardize the results across all products, the DIN 3586 requires testing of the trigger temperature point with no flow. Follow-up discussions with the manufacturers confirmed that their published test results were achieved without flow conditions and that the temperature at which thermal shutoff devices trigger is dependent on the flow rate going through the device, which explains the difference in results. Prior tests on the Teco FireBag® device performed at GTI (Project 20835.1.08) showed that in a no flow condition, the tripping temperature of the devices meets the manufacturer's published temperature. Depending on construction materials, a typical residence fire can be expected to reach temperatures of 1100°F, this is well above the highest activation temperature of 472°F measured during this project.

Overall, the performance test results of this project support that thermally-activated shutoff devices can be relied on, if installed per manufacturer's instructions, to secure the flow of natural gas when exposed to elevated temperatures from a structure fire.

Future projects related to thermally-activated devices to consider.

- Development efforts for creating a U.S. and Canadian standard(s) for governing thermally-activated shutoff devices.
- Conduct performance testing of high-pressure rated thermally-activated shutoff devices at low delivery pressures to confirm satisfactory pressure drops.
- Conduct performance testing at elevated flow rates to identify activation temperatures.
- Research and development efforts to incorporate an EFV device into high-pressure rated thermally-activated shutoff devices.

References

U.S. Fire Administration - Residential Building Fire Trends (2008 - 2017)

https://www.usfa.fema.gov/downloads/pdf/statistics/res_bldg_fire_estimates.pdf

Gas Technology Institute. 2012. "Firebag Fittings Flow Measurement for sizes ½", ¾", & 1." Project Report 20835.1.08 and 111724

List of Acronyms

Acronym	Description
ANSI	American National Standards Institute
ASME	American Society of Mechanical Engineers
BSPP	British Standard Pipe Parallel
BTU	British Thermal Unit
CFH	Cubic Feet per Hour
DSC	Differential Scanning Calorimetry
EFV	Excess Flow Valve
FTIR	Fourier Transform Infrared spectroscopy
GTI	Gas Technology Institute
PSIG	Pounds Per Square Inch Gauge
SCFH	Square Cubic Feet per Hour
WC	Water Column
US	United States

END OF REPORT